

# INSIDE GROOVE DIGITAL CALIPER

## OPERATING INSTRUCTIONS

NO.129

Thank you for purchasing this digital caliper.  
Read the following instructions carefully before using this product.

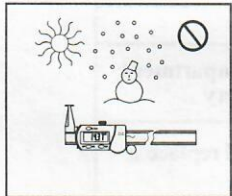
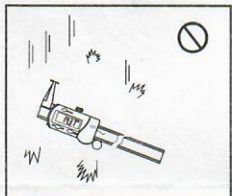
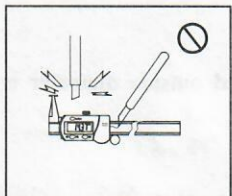
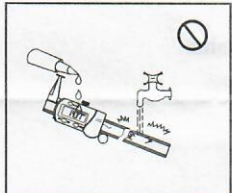

### IMPORTANT

- Keep caliper face clean. Prevent liquid from getting into slider.
- Do not mark caliper with any type of electronic engraving pen. Do not scratch scale.
- Avoid any type of impact to caliper. Place caliper in a safe, open area free of debris as a precaution.
- Do not operate caliper in direct sunlight. Do not store caliper in an area of extreme temperature.
- Clean caliper face with petrol only. Lubricate caliper with a few drops of oil lock oil. **DO NOT USE ACETONE OR ALCOHOL ON CALIPER.**
- Do not remove end lid without using output interface. Output end should never be connected with metal. Doing so could damage your caliper.
- Always use SR44 (silver oxide cell) battery in caliper.
- Do take out of the battery if not in use for a long time.

### CALIPER FEATURES

- |                          |                           |
|--------------------------|---------------------------|
| 1. Inside Measuring Face | 2. Inch/mm Switch         |
| 3. Slider Clamp Screw    | 4. Preset Positive Switch |
| 5. Output Connector      | 6. Preset Negative Switch |
| 7. Main Scale.           | 8. Beam                   |
| 9. Thumb Roller          | 10. Battery               |
| 11. Preset /Set Switch   | 12. ON/OFF Switch         |
| 13. LCD                  |                           |

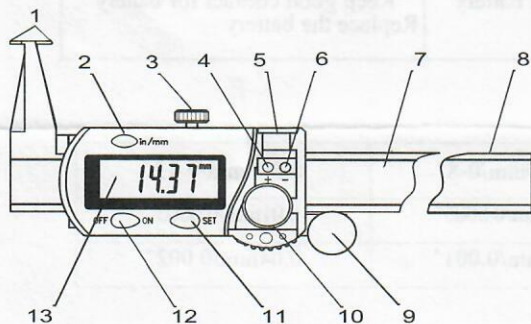

### FUNCTIONS

- This caliper features mm/inch change-over and presetting at any position.
- On the upper right side of the slider is a serial output, which can interface with a computer or printer via a special converter to process data.

### BEFORE OPERATION

- Before using this caliper for the first time, wipe the rust preventative oil over the caliper using a soft cloth.
- Remove battery compartment lid and insert SR44 battery with its positive (+) side facing upward.



## INSTRUCTIONS

### Presetting

After inserting or replacing the battery, preset according to the following steps:

1. Press the key "SET" and "+" or "SET" and "-" at the same time, then LCD appears the presetting indicator "SET".
2. Press the key "+" once, the value increases one point; Press the key "+" continuously, the value increases point by point. Press the key "-" the same as the key "+", then decreases one point or point by point.
3. Repeat the step (2) until LCD appears the value equal to the dimension of calibrated gauge's diameter. For example presetting value 10.00 (as the standard value of the calibrated gauge provided).
4. Press the key "SET" again, then presetting value 10.00 is saved. when pressing the key "SET" at any scale position, LCD appears the presetting value "10.00".

Attentions: replace the battery in 5 seconds, the preset is kept memory, otherwise those steps should be repeated.

### Measuring Operations

1. Put the calibrated gauge into the jaw and press the key "SET", LCD indicates the presetting value.

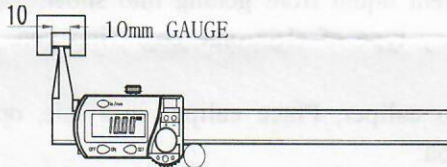

figure 1

2. Put the inside measuring face into the GROOVE (see figure2), so the value of tested outside diameter is easy-to-read.

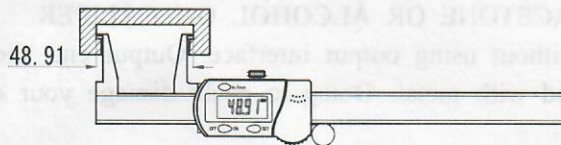

figure 2

## TROUBLE SHOOTING

Failure	Possible Situation	Solutions
Five digits appear simultaneously and change rapidly	Battery power low	Remove battery compartment lid and re-place battery
The display does not work (only when changing battery)	Circuit accidental pause caused by poor voltage when fixing battery	Remove battery and replace it after 30 seconds
Reading error for full length is $\leq 0.1\text{mm}$	Dirt has damaged/covered sensor	Remove cover and slider assembly. Apply a small layer of petrol to avoid dirt build-up
Nothing appears on the LCD	Battery has poor contact battery voltage is under 1.1V	Keep good contact for battery Replace the battery

## SPECIFICATIONS

Measuring range	0-150mm/0-6"	0-200mm/0-8"	0-300mm/0-12"
Resolution	0.01mm/0.0005"	0.01mm/0.0005"	0.01mm/0.0005"
Accuracy	0.02mm/0.001"	0.03mm/0.001"	0.04mm/0.002"

Repeatability : 0.01mm/0.0005"

Maximum Measurement Speed : 3m/s – 120in/s

Operating Temperature : 0°C~ 40°C

Storage Temperature : -10°C~ 60°C

Power : 1.5V SR44 (silver oxide cell) – 1 battery

Battery Life : The warranty is about one year under normal use.